



Matthias Brück, Roxtec AB
Segment Manager Wind Power EMEA



The Company



- 1990 gegründet in Karlskrona
- Teil der Mellby Gård AB
- CEO: Mikael Helmerson
- 24 Niederlassungen
- Kunden in über 80 Ländern
- ISO 14001 und ISO 9001 zertifiziert

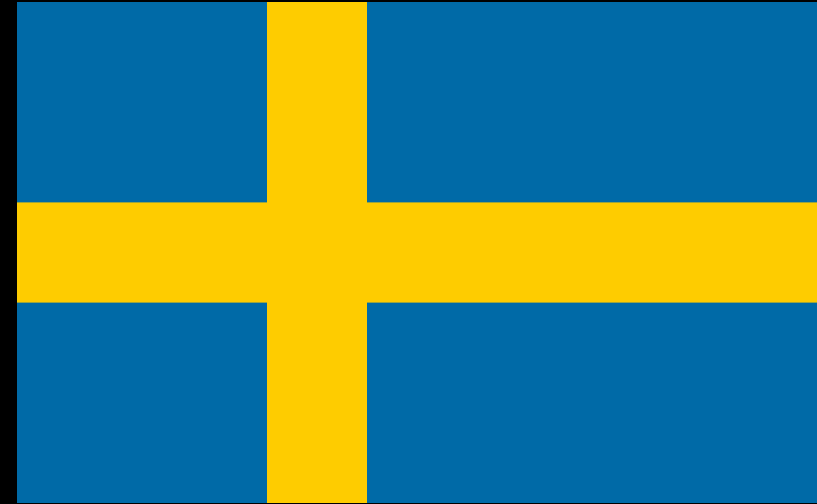

Flexible Dichtungslösungen

- Roxtec bietet Lösungen in allen Bereichen:
- An Land, OEM – Telekom & Schiffbau / Offshore
- Wo immer Kabel und Rohre verlegt werden!



Roxtec in WEA

- Kabeleinführung Gondel



Roxtec in WEA

- Loopaufhängung

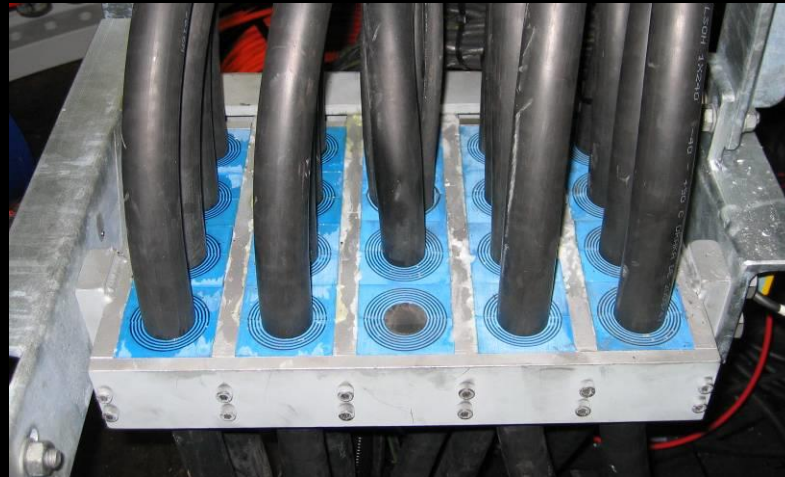

Roxtec in WEA

- Schaltschränke



Roxtec in WEA

- Sonderlösungen



Roxtec in WEA

- Umrichterschränke
- Potential Ausgleich
- elektromagnetische Abschirmung
- Erdung



Roxtec in WEA

- Turmeinführungen



Roxtec in WEA

- Transformatoren

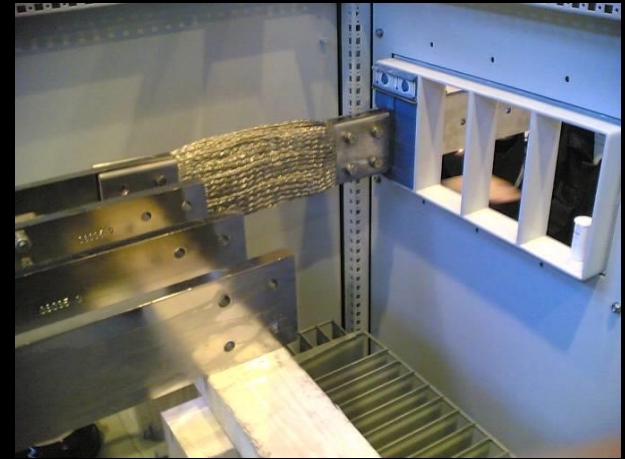



Int



Kabeleinführungen im Untergrundbereich



Kabeleinführungen im Untergrundbereich

- Kabelführung



Warum traditionelle Dichtungsmasse bei Hochspannungskabeln versagt

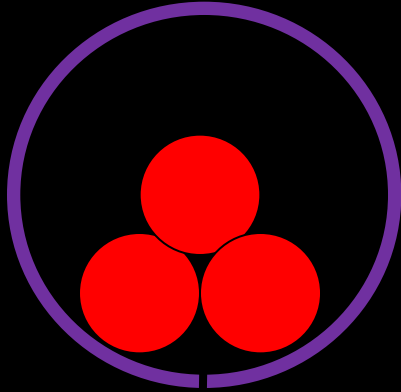

unmöglich
Dichtmasse
zwischen oder
unter die Kabel zu
bekommen

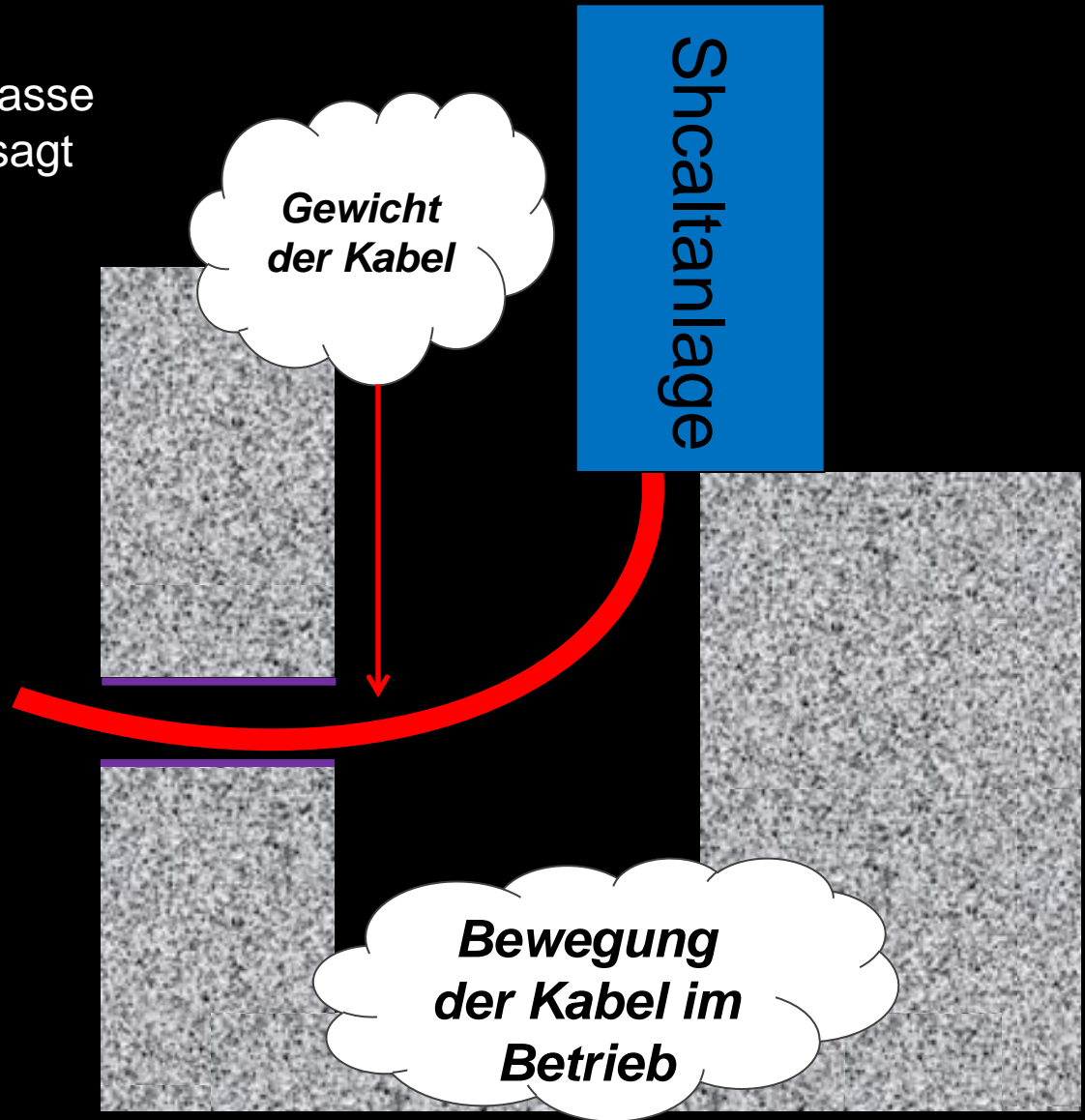

€300,-



€100,-



€100,-



Schaltanlage

Wartungskosten können gesenkt werden wenn eine richtige Kabeleinführung eingebaut wird!

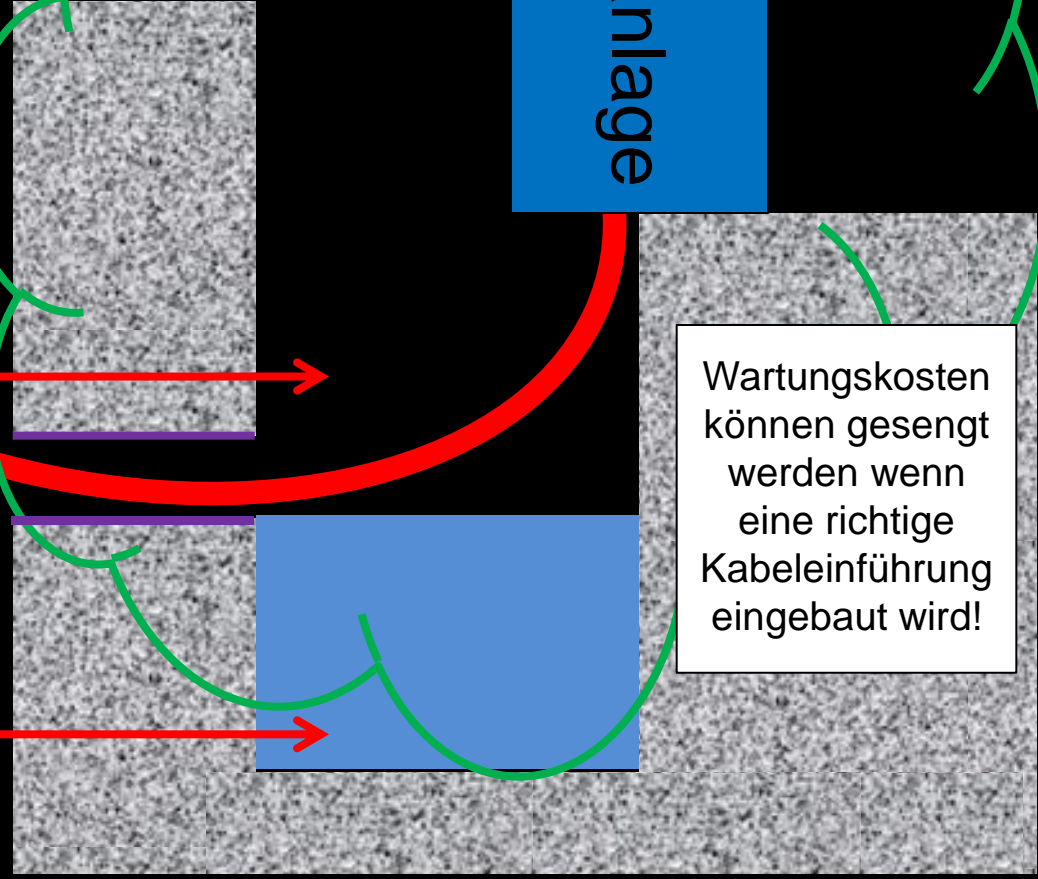

Kabelführung

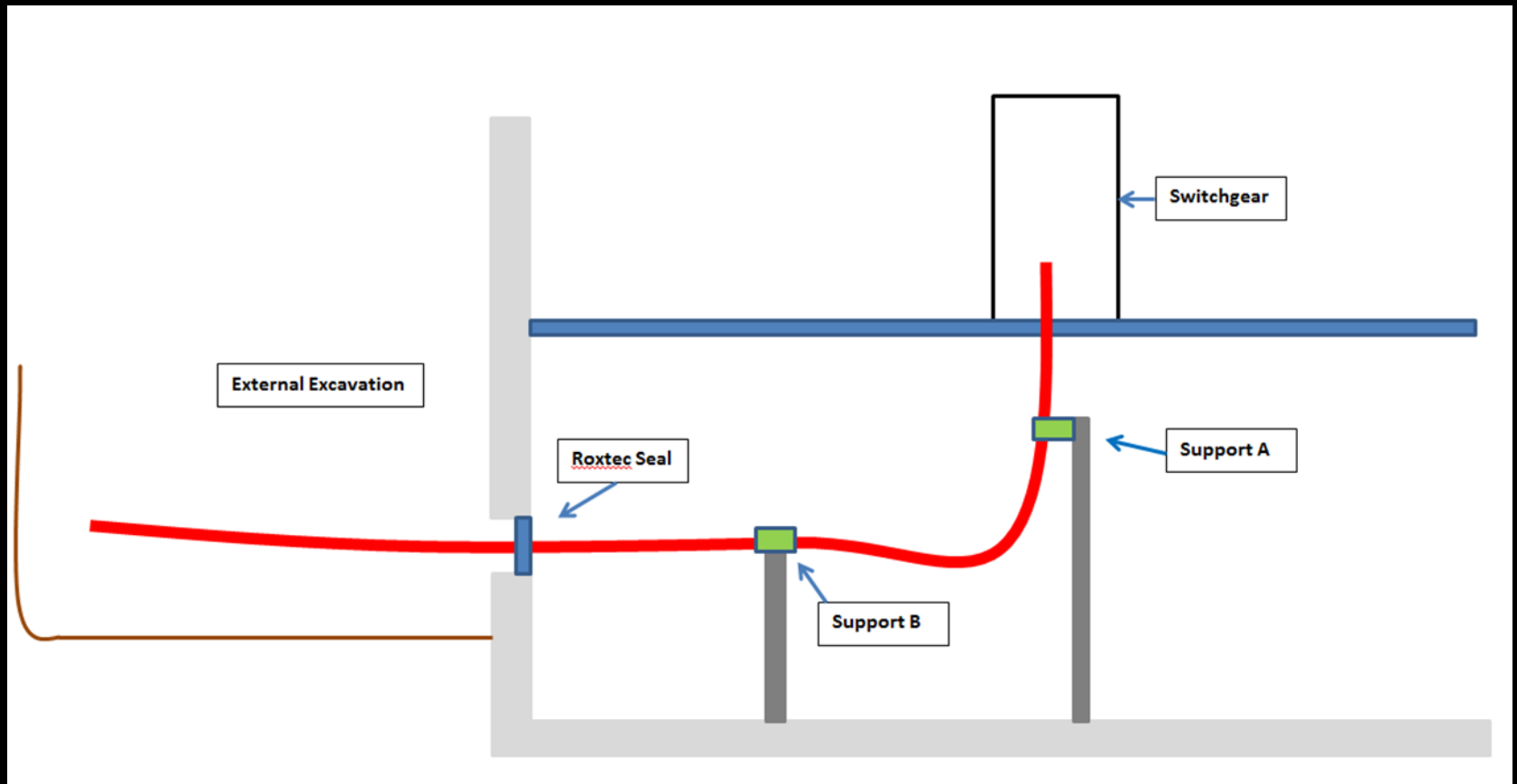

Primary substation 132kv Retrofit



Best Practice Design

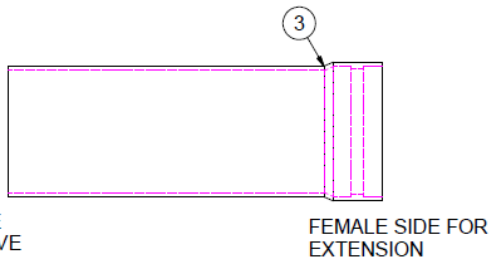
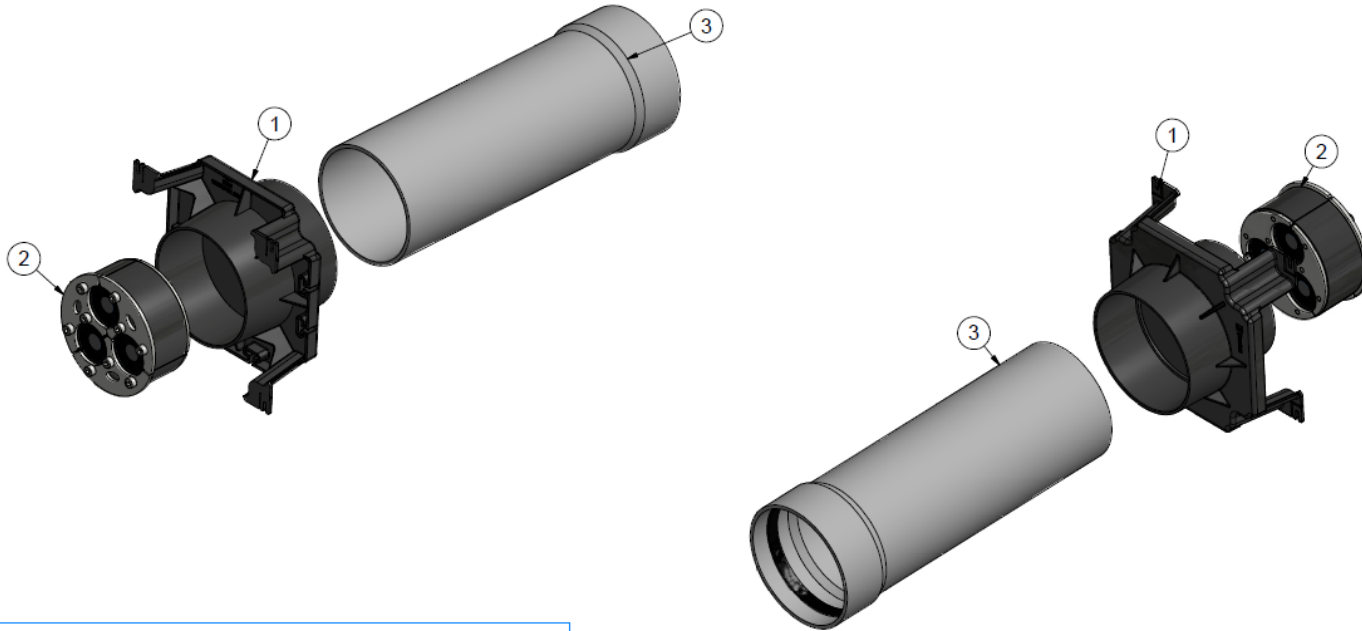

A		2015-10-02	se-jenboh
Rev	Type of revision	Date	Sign

3	-	EXTENSION PIPE							1.2
2	-	H3 UG SEAL							6.4
1	-	KNOCK OUT SLEEVE							0.8
ITEM	QTY	Designation			Specification				Weight
General reference:		Product spec:	General spec:	Designed by/date:	Latest save date:	Format:	Scale:	Sheet no:	Tonnage:
ISO 2789-12-nr		EN ISO 8817-8		se-jenboh	2015-10-02	2015-10-02	A3	1 / 1	N/A
EN ISO 13363-01		EN ISO 19542-8	Re: 133	Title		Projection method		Rev	
				www.roxtec.com		UNDERGROUND ASSEMBLY EXTENSION PIPE		Restricted due to	
						Drawing number		S1506967	
								A	

KOS / Kompaktstation Windpark Finland

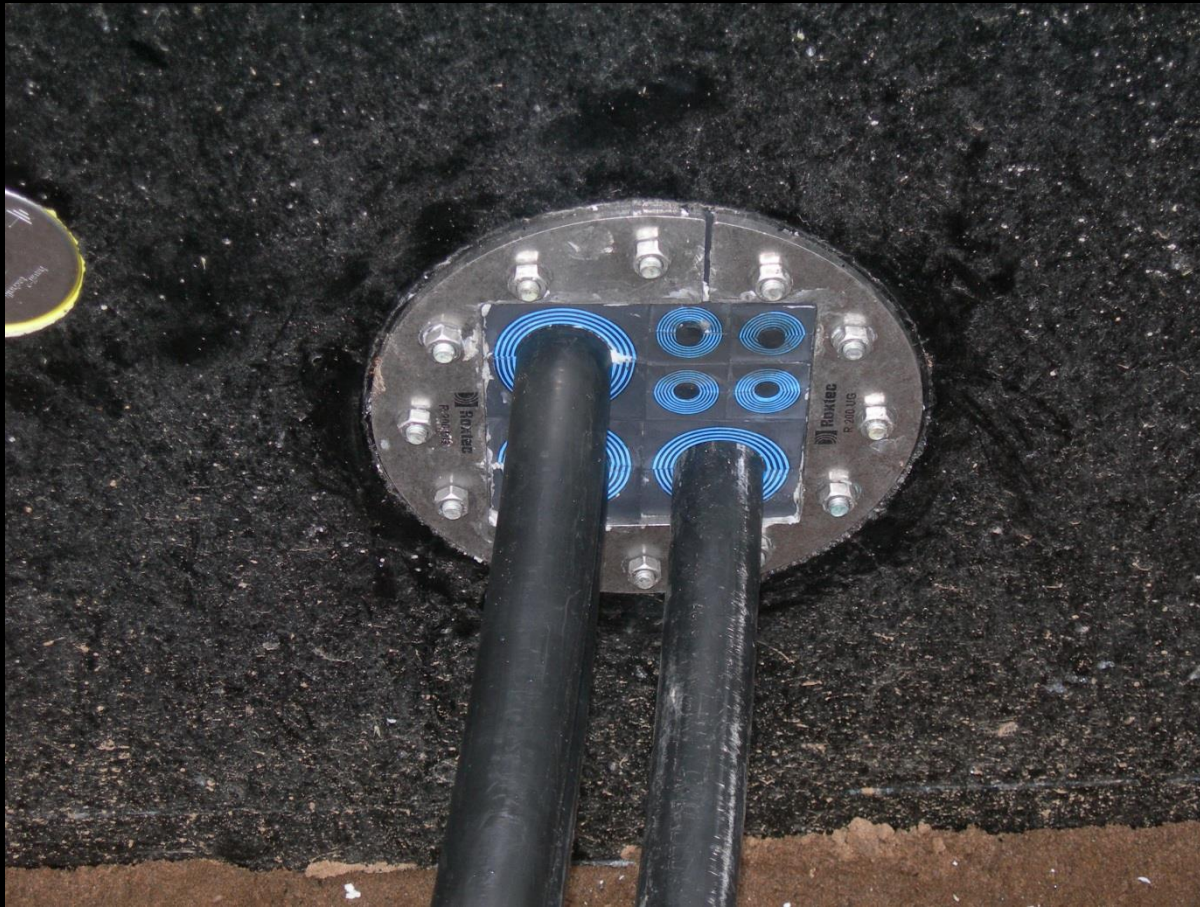

KOS Installation,
Dubai,
Prototype version



Substation in Scotland





Substation in Scotland Installationvideo

Unsere Kunden in der Windenergie

- Vestas / MHI
- Siemens Wind Power
- Senvion GmbH
- Adwen GmbH
- Nordex SE
- Alstom
- GE Wind Energy
- Gamesa
- Iberdrola / Scottish Power
- RWE
- E.ON
- ENBW
- Bladt
- Ambau
- Smulders
- Heerema Yard
- Cofily Fabricom
- Nordic Yards
- ABB
- Siemens

Vielen Dank

Matthias Brück

Segment Manager Wind Power EMEA

Roxtec GmbH
Neuer Höltigbaum 1-3
22143 Hamburg

matthias.brueck@roxtec.com

Mobil: +49-172 439 24 62

Tel: +49-40-657 398-18

Fax: +49-40-657 398-50/51

www.roxtec.com

